

CyberPower®

User's Manual for CyberShield CSN27U12V

CyberShield UPSs are designed to provide a local power solution for cable telephony, wireless local loop (WLL), and fiber to the home (FTTH) broadband equipment.

IMPORTANT SAFETY WARNINGS (SAVE THESE INSTRUCTIONS)

This manual contains important instructions regarding the installation and operation of this device. Read this manual thoroughly before attempting to unpack, install or operate this device.

- CAUTION!** The battery can energize hazardous live parts inside even when the AC input power is disconnected.
- CAUTION!** To prevent the risk of fire or electric shock, install in a temperature and humidity controlled indoor area, free of conductive contaminants. (Please see specifications for acceptable temperature and humidity range).
- CAUTION!** To reduce the risk of electric shock, do not remove the cover, except to service the battery. No user serviceable parts inside, except for the battery.
- CAUTION!** To avoid electric shock, turn off the unit and unplug it from the AC power source before servicing the battery or installing a computer component.
- CAUTION!** When replacing batteries, the replacement should have the same rating as follows, Listed/Certified Valve Regulated Lead Acid Battery, 12V, max. 9Ah.
- CAUTION!** Risk of Energy Hazard, 12V, max.9 Ampere-hour battery. Before replacing batteries, remove conductive jewelry such as chains, wrist watches, and rings. High energy through conductive materials could cause severe burns.
- CAUTION!** Do not dispose of batteries in a fire. The batteries may explode.
- CAUTION!** Do not open or mutilate batteries. Released material is harmful to the skin and eyes. It may be toxic.

ENCLOSURE INSTALLATION

Carefully follow these instructions during installation of this device:

- 1.) Carry out the installation in a safe area that is free of excessive dust and has adequate airflow.
- 2.) Screws must be appropriate for total weight of the UPS and the mounting surface material.
- 3.) Do not operate the UPS where the temperature and humidity are outside the specified limits. (Refer to specification in this manual.)

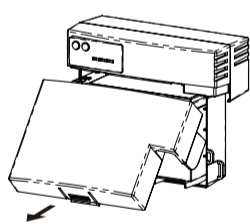

Step 1:
a. Remove the battery cover.

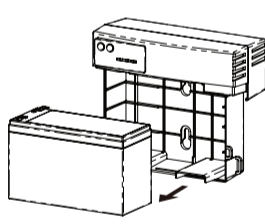

Step 2:
a. Slide battery off of the shelf.
b. Disconnect battery cable connector at chassis end.

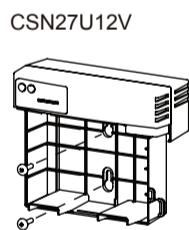

Step 3:
a. Use the enclosed installation template to mark an installation location for the unit.
b. Mount the unit on the wall with 2 mounting screws into the keyhole slots.
c. Tighten the screws to secure the units.
d. Connect the battery connector and replace the battery back.

Note: please always mount the unit on the wall when it is working.

BATTERY REPLACEMENT

This battery is hot-swappable. As long as utility power is on, you may leave the UPS and connected equipment on while replacing a new battery.

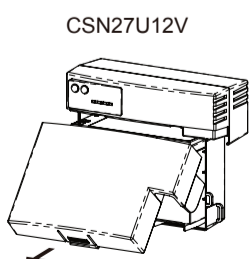

Step 1:
a. Remove the battery cover.

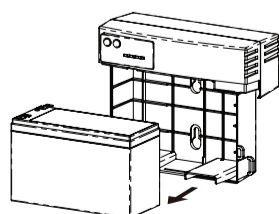

Step 2:
a. Disconnect battery cable connector to remove battery.
b. Replace with new battery and re-connect the battery connector.

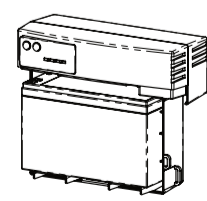

Step 3:
a. Make sure battery is fixed properly in the compartment and close the battery cover.

OPERATION

Connect equipment and power:

- Step1. Plug the UPS power cord into the utility power cord inlet.
- Step2. Plug the UPS power cord into the wall outlet.



The UPS battery charges when it is connected to utility power. The battery charges fully during the first **24 hours** of normal operation. Do not expect full battery run capability during this initial charge period.

BATTERY EMERGENCY USE / COLD START (-BC1 OPTION)

The Battery Emergency Use feature allows emergency reserve time available in the battery to be utilized for 911 or emergency calls, providing additional talk time depending on use and conditions. The cold start feature is for applying power to the UPS and connected equipment when the UPS is off and there is no utility power. Before using the cold start feature, please make sure the battery is charged. To start the cold start feature, press the cold start button on the upper left corner of the unit.

ALARM SILENCE

The audible alarm will be enabled when the unit is operating from battery or battery power is low. Press the button for 3 seconds to disable or enable the audible alarm.

The unit will beep once confirming that audible alarms have been disabled. Press this button a second time to enable audible alarms. The unit will beep twice confirming that audible alarms have been enabled.



Once the battery is disconnected, the connected equipment is not protected from power outages.



Pb

Deliver spent batteries to a recycling facility or ship to the manufacturer in the replacement battery packing material.

WARNING INDICATOR

Indicator	Color	Condition
	Green	Indicates normal mode of operation.
	Green	Indicates the battery is supplying the power. At 45% battery capacity, the LED will flash and then alarm will beep 4 times per minute.
	Orange	Press and hold the button "Alarm Silence" for 0.5 second to silence the audible alarm for 24 hours, and the LED will flash.
	Red	Battery replacement required. Alarm will beep once every 15 minutes. The LED also illuminates when battery is absent.

COMMUNICATION SIGNALS

The communication signals of this unit are isolated from the internal circuitry via open collector opto-coupled transistors. The connection "SIG RTN" (Signal Return) is a common return point for all communication signals. In the typical application, the attached equipment digital ground connects to Signal Return, and pull-up resistors turn the open collector signals into logic levels.

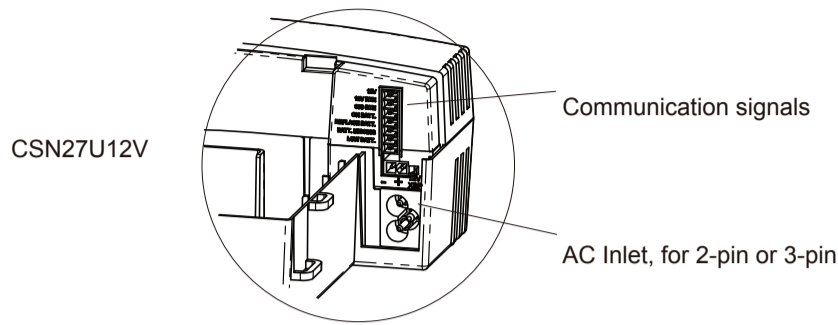

CSN27U12V	Message
12V	+ Voltage output
12V RTN	- Voltage output
SIG RTN	Signal return
ON BATTERY	Low when operating from utility line. Open when operating from battery.
REPLACE BATTERY	Low when battery is charged. Open when battery fails the Self Test.
BATTERY MISSING	Low when battery is present. Open when battery is missing.
LOW BATTERY	Low when battery is near full charge capacity. Open when operating from a battery with < 20% capacity.

AUXILIARY POWER SOURCE

When connecting the UPS to an auxiliary power source, please use a listed Valve Regulated Lead Acid Battery with 12Vdc output voltage. Using a battery with incorrect voltage may cause risk of energy hazard.

SPECIFICATION

Model	CSN27U12V
Input	
Voltage Range	90Vac ~ 264Vac (Universal Input)
Frequency Range	47 - 70 Hz
Output	
On Battery Output Voltage	12Vdc
Continuous Power Capability	27W
Output Power Max	30W (< 5 sec)
Efficiency (at 75% Max Load)	≥ 80%
Battery	
Battery Type	Sealed, Maintenance Free Lead-Acid Battery
Numbers of Battery	7.2AH/12V x 1
Typical Recharge Time	14 Hours (90% charged)
Replaceable	Yes
Surge Protection and Filtering	
Lightning / Surge Protection	Yes
Warning Diagnostics	
Indicators	System Status, DC, Mute, Replace Battery
Management	
Auto-Charge	Yes
Communication Interface	On Battery, Replace Battery, Battery Missing, Low Battery
Physical	
Maximum Dimensions (L*W*D)	16.7cm x 19 cm x 8.3 cm
Weight (kg)	3.03
Environment	
Operating Temperature	-4°F - 113°F (-20°C - 45°C)
Operating Humidity	0 - 95% noncondensing within enclosure
Max Operating Elevation	10,000ft (3,000m)
Max Storage Elevation	50,000ft (15,000m)
Storage Temperature	-4°F - 113°F (-20°C - 45°C)

LIMITED WARRANTY

CyberPower warrants to you, the Initial Purchaser, that the Product will be free from defects in material and workmanship for three years from the date of original purchase, subject to the terms of this Limited Warranty. This Limited Warranty gives you specific rights, and you may have other rights, which vary from State to State or Province to Province.

Any Implied Warranty of Merchantability or for Fitness for a Particular Purpose, if applicable to the Product, is limited in duration to three years. This provision shall NOT create any Implied Warranty or Merchantability or of Fitness for a Particular Purpose that would not otherwise apply to the Product. NOTE: **Some States and Provinces do not allow limitations on how long an implied warranty lasts, so the above limitation may not apply to you.**

To be covered you must still be the owner of the Product at the time of the failure that results in the claim made under this Limited Warranty. Your sole and exclusive remedies are those provided by this Limited Warranty. This exclusion of other express warranties applies to written and oral express warranties. CyberPower excludes any liability for personal injury. CyberPower excludes any liability for direct, indirect, special, incidental, or consequential damages, whether for damage to or loss of property, loss of profits, business interruption, information or data. This exclusion applies even though damage or loss is caused by negligence or other fault. NOTE: Some States or Provinces do not allow the exclusion or limitation of incidental or consequential damages, so the above limitation may not apply to you.

DO NOT USE FOR MEDICAL OR LIFE SUPPORT EQUIPMENT OR OTHER HIGH RISK ACTIVITIES.

CyberPower does not sell the PRODUCT for use in high-risk activities. The PRODUCT is not designed or intended for use in hazardous environments requiring fail-safe performance, including the operation of nuclear facilities, aircraft navigation or communication systems, air traffic control, weapons systems, life support or medical applications or for use in any circumstance in which the failure of the PRODUCT could lead directly to death, personal injury, or severe physical or property damage, or that would affect operation or safety of any medical or life support device (collectively, "High Risk Activities").

CyberPower expressly disclaims any express or implied warranty of fitness for High Risk Activities. CyberPower does not authorize use of any PRODUCT in any High Risk activities.

ANY SUCH USE IS IMPROPER AND IS A MISUSE OF A CYBERPOWER PRODUCT.

The Limited Warranty is governed by the laws of the United States and the State of Minnesota, without reference to conflict of law principles. The application of the United Nations Convention of Contracts for the International Sale of Goods is expressly excluded

FCC NOTICE:

This equipment has been tested and found to comply with the limits for a Class B digital device, pursuant to part 15 of the FCC Rules. These limits are designed to provide reasonable protection against harmful interference in a residential installation. This equipment generates, uses and can radiate radio frequency energy and, if not installed and used in accordance with these instructions, may cause harmful interference to radio communications. However, there is no guarantee that interference will not occur in a particular installation. If this equipment does cause harmful interference to radio or television reception, which can be determined by turning the equipment off and on, the user is encouraged to try to correct the interference by one or more of the following measures: (1) Reorient or relocate the receiving antenna. (2) Increase the separation between the equipment and receiver. (3) Connect the equipment into an outlet on a circuit different from that to which the receiver is connected. (4) Consult the dealer or an experienced radio/TV technician for help.

CAUTION: Shielded signal cables must be used with this device to ensure compliance with Class B FCC limits.

CAUTION: Any changes or modifications not expressly approved by Cyber Power could void the authority granted by the FCC to operate this equipment.

For more information, please contact:

CyberPower Systems (USA), Inc. 4241 12th Avenue East, Suite 400, Shakopee, MN55379 Phone: (952)403-9500 Fax: (952)403-0009 www.cpsww.com

CyberPower Systems (EUROPE), Inc.. Flight Forum 3545, 5657DW Eindhoven, The Netherlands E-mail: sales@cyberpower-eu.com eu.cyberpowersystems.com